

AMERICAN RANGE

PROFESSIONAL QUALITY COOKING EQUIPMENT

MEDALLION SERIES

48" Range with Dual Fuel Self Clean Oven and Sealed Gas Burners



ARR-4822GDDF

(shown with optional island back and leg caps)

DESIGN



CLASS



FUNCTION

DESIGNED & BUILT IN USA
PROFESSIONAL COOKING EQUIPMENT

48" RESIDENTIAL DUAL FUEL RANGE

RANGE TOP FEATURES

- Sealed burners deliver exceptional performance at every level setting and lift off to provide easy clean-up
- 3 sizes of burners to serve your everyday needs: 17,000 BTU (lg), 13,000 BTU (med), 9,000 BTU (sm)
- Variable infinite flame settings for all sealed top burners
- Fail-safe system ensures re-ignition in the event the flame goes out
- Continuous and flush commercial-grade cast iron grates allow for easy transfer of pots and pans across the entire cooking surface
- Blue LED lights indicate flame and oven functions provided with every knob
- Heavy metal die-cast black satin knobs with chrome bezels
- Sealed Single Piece tooled stainless steel cook top can hold a gallon of spills
- Electronic keypad with blue VFD display
- Multiple functions include: Full Power modes for Standard Bake, Convection Bake, Infrared Broil, or Warm modes for Dehydrate, Crisping and Proofing

OVEN FEATURES

- Traditional and Convection Bake can be controlled from 150°F to 550°F
- Infrared energy from hidden bake and broil elements shine through high transparency glass ceramic windows
- 3,500 Watt Instagrill™ broiler reaches searing temperature in 3 seconds
- Stainless steel air flow directors provide even distribution of convection air for uniform oven temperatures
- Commercial grade high performance thermal insulation keeps kitchen cool
- Two chrome racks glide at 5 (including base) cooking levels on heavy chrome side supports
- Accommodates full size commercial sheet pan
- Commercial grade porcelainized oven interior for simple cleaning
- Programmable timed self clean for effortless oven maintenance

ACCESSORIES AND OPTIONS

Island back (standard)	ARR-48SIB-M	Casters (Set of 3)	ARR-3CAS-M	24" Griddle Cover	ARR-GDCOV24-S-M	22" Chrome Grooved Griddle	MC-GG-M
Island back (welded)	ARR-48IB-M	12" Cutting Board	ARR-CUTB12-M	24" Grill Cover	ARR-GRCOV24-M	22" Chrome Griddle w/ Separator	MCGG-M
4" Stub Back	ARR-484SB-M	12" Griddle Cover	ARR-GDSCOV12-S-M	11" Chrome Flat Griddle Plate	MC11-FS-M	Porcelainized Broiler Pan	R31005
20" High back w/ Shelf	ARR-4821HBS-M	12" Grill Cover	ARR-GRCOV12-S-M	11" Chrome Grooved Griddle Plate	MC11-GG-M	Wok Adapter	ARR-WOK-M
S/S Curb base	ARR-48CB-M	12" Griddle Plate	ARR-PGP12-M	22" Chrome Flat Griddle Plate	MC22-FS-M		
Stainless Steel Leg Caps (3)	ARR-3LC-M	24" Griddle Plate	ARR-PGP24-M	22" Chrome L- Flat R - Grooved Griddle	MC-HG-M		

STRAIGHT CONVECTION™ TECHNOLOGY

American Range is pleased to introduce Straight Convection™ Technology. Borrowing from the aerospace industry, we've circled our convection bake fan with a powerful ring heater - and straightened out the hot air stream using proprietary air directors. The result is shorter cooking times and more uniform heat transfer for multiple rack cooking - saving time and energy!

COMMERCIAL HERITAGE

American Range introduces the new dual fuel range for the home - a kitchen cooking product for the best of both worlds. The dual fuel range combines the accurate temperature control of the electric oven cell - with the speed and power of our industry-leading gas range top. When you add in our rugged, commercial design and construction heritage, as can be expected, the whole is far greater than the sum of its parts.

TECHNICAL SPECIFICATIONS

Overall Oven Capacity	2.7 CU. FT. (18" oven) - 4.7 CU. FT. (30" oven)
Oven Dimensions	14 - 1/2" W x 20 - 1/2" D x 15 - 1/2" H 26 - 1/2" W x 20 - 1/2" D x 15 - 1/2" H
Surface Burner Rating	17,000 BTU (lg) - 13,000 BTU (md) - 9,000 BTU (sm)
Griddle Burner Rating	20,000 BTU - every 11" section
Grill Burner Rating	18,000 BTU - every 11" section
Infrared Broiler Burner	13,500 BTU - (18" oven)
Oven Bake Burner	28,000 BTU
Infrared Broiler Element	3,500 Watts - (30" oven)
Oven Bake Burner Element	3,500 Watts - (30" oven)
Convection Ring Element	2,200 Watts - (30" oven)
Total Gas Connection Rating per model #	ARR-486GDDF 142,000 BTU 6 burner and griddle ARR-486GRDF 140,000 BTU 6 burners and grill ARR-4842GDDF 132,000 BTU 4 burners, double griddle ARR-484X2GRDF 128,000 BTU 4 burners, double grill ARR-484GDRDF
Gas Supply	7" W.C. Natural, 11" W.C. Propane
Electrical Supply	120VAC 30 AMP 60 Hz Single Phase
Shipping Weight	680 Lbs

CUSTOMIZE YOUR RANGE: Now you can customize your American Range to match your kitchen setting. Pick from numerous colors and finishes to give your range a unique one-of-a-kind look. For more details regarding color and finish options, go to our website: www.americanrange.com.

DESIGNER COLORS



DESIGNER FINISHES

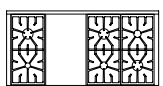

N = Natural gas
L = LP Gas
Must ship from factory with proper gas type.
Must provide **N** or **L** after model number for type of gas needed.
Example: ARR-304
Must specify elevation if over 1000 ft. when ordering.

ARR-486GDDF

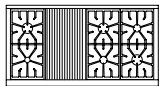

ARR-486GRDF

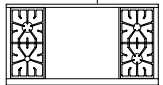

ARR-4842GDDF

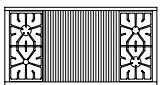

ARR-484X2GRDF

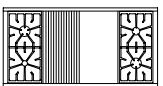

ARR-484GDRDF

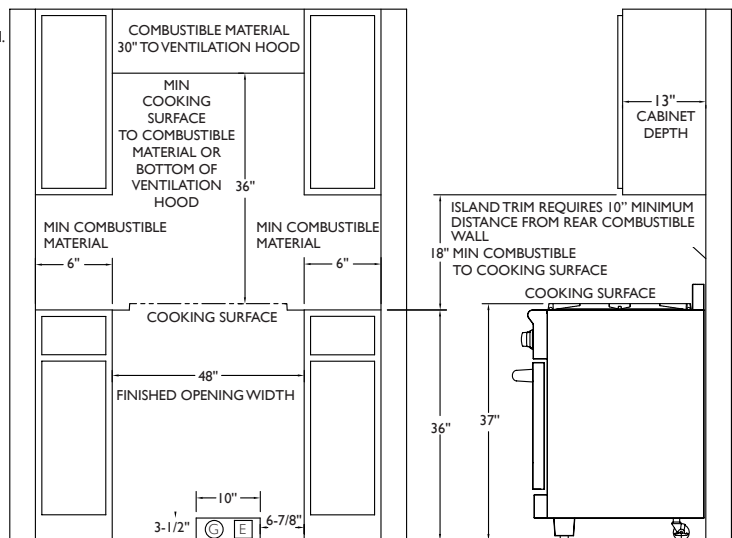
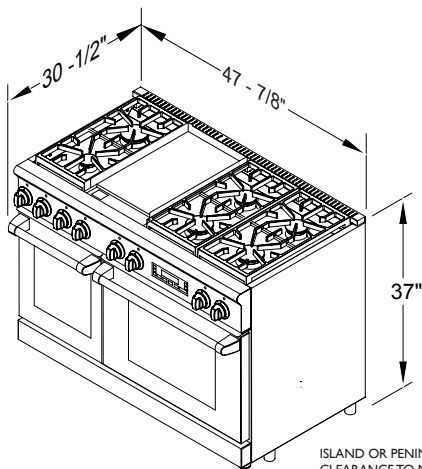

ISLAND OR PENINSULA INSTALLATIONS 10" MINIMUM CLEARANCE FROM BACK OF RANGE TO COMBUSTIBLE SURFACE ISLAND TRIM IS 0".
CLEARANCE TO NON COMBUSTIBLE SURFACE
NO SIDE WALL ABOVE COOKING SURFACE